



aerospace
climate control
electromechanical
filtration
fluid & gas handling
hydraulics
pneumatics
process control
sealing & shielding



Parker Angle Seat Valves

PA Series, 2/2 Way, NC or NO
3/8" to 2 1/2" BSP, 16 Bar



ENGINEERING YOUR SUCCESS.

Parker Angle Seat Valves

Introduction

An angle seat valve is actuated by a pneumatically driven piston and is capable to handle slurry solutions with particles or corrosive solutions at high temperature up to 180°C and operating pressure up to 16 Bar.

Benefits

- Compact design, high flow rates
- Visual position indicator
- For temperatures from -10°C to 180°C
- Working pressures up to 16 Bar
- Dampened closing anti-water hammer design (fluid under seat)
- Stainless Steel actuator housing for exceptional durability in steam and aggressive applications
- Valves meeting Pressure Equipment Directive 97/23/EC
- Mountable in any position
- Tight shut-off and Long Service Life
- Parker Angle Seat Valves conform to the terms of the 94/9/CE directive specific to non electrical equipment for use within potentially explosive environments - zones 1/21 and 2/22

Applications

Angle seat valves are suitable for many process and industrial applications:

- Food and Beverage Processing
- Water Technology & Treatment
- Textile Industry
- Cooling systems on injection molding machines
- Pharmaceutical & cosmetic industry
- Chemical Process technology
- Refrigeration & Cooling heat exchangers
- Sterilizers steam supply
- Water applications: Mining, Cement / Concrete Systems, Pulp & Paper
- General industrial applications of aggressive fluids
- Industrial Laundry Equipment
- Industrial Air Dryers

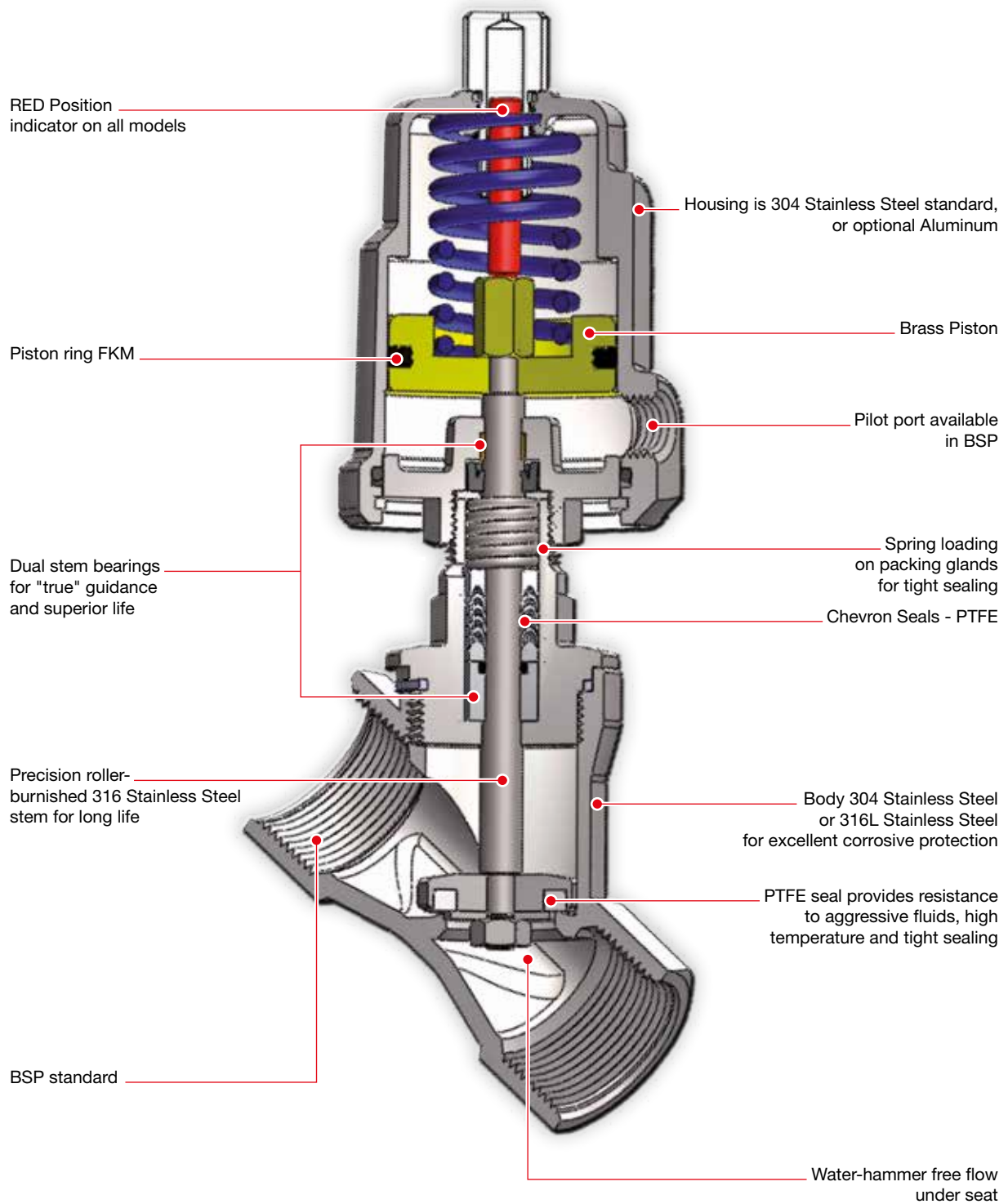

Table of Content

- Key Features 04
- General Specifications 05
- Normally Closed
Flow Direction Over the Seat 06
- Normally Open
Flow Direction Over the Seat 10
- Normally Closed
Flow Direction Under the Seat
Anti Water Hammer Construction 11
- Compact Design Normally Closed
Flow Direction Over Seat 13
- Compact Design Normally Closed
Flow Direction Under Seat 14
- Drawings and Dimensions 15
- Numbering System 16
- Solenoid Valves for Controlling
the PA Angle Seat Valves 17



Key Features



General Specifications

PA Series, 2/2 Way, NC or NO
3/8" to 2 1/2" BSP, 16 bar



- Body Material 304 Stainless Steel or 316 Stainless Steel
- Actuator Material 304 Stainless Steel, or Aluminum
- Function 2/2 NC, NO, NC (anti-water hammer)
- Port size from DN 10 (3/8") to DN 65 (2 1/2")
- Connections: Threads BSP
- Max Working Pressure 16 Bar
- Flow factor KV from 4.7 m³/h (DN10) to 70 m³/h (DN 65)
- The PA Series angle seat valves comply with European Pressure Equipment Directive 97/23/EC
- Parker Angle Seat Valves conform to the terms of the 94/9/CE directive specific to non electrical equipment for use within potentially explosive environments - Zones 1/21 and 2/22 - Protection II 2 GD c TX
- Pilot Pressure 3 Bar min to 10 Bar according to control pressure charts
- Maximum Fluid Temp -10°C to 180°C
- Ambient Temperature -10°C to 60°C
- Seat Seal material PTFE/RTFE
- Packing Gland: PTFE and PTFE with Carbon
- Installation Any Position
- Optical Position Indicator Standard on all sizes
- Pilot Control Media Air, Neutral Gas
- Fluids handled: Inert gases, hot water, oils, steam, aggressive and corrosive fluids
- Weight from 0.58 Kg (DN10) to 8.65 Kg (DN 65)
- Viscosity: Maxi. 600 mm²/s (600cSt, 80° E, 2700 SSU)

For liquids, use versions with flow direction under the seat.

Accessories

- Spare Parts Kits are available for main seat and body gasket replacement (on request)
- 3 Way Direct Acting AC & DC Pilot Control Valves available as separate components

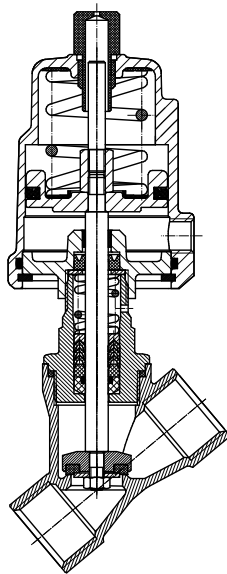

Normally Closed Valve

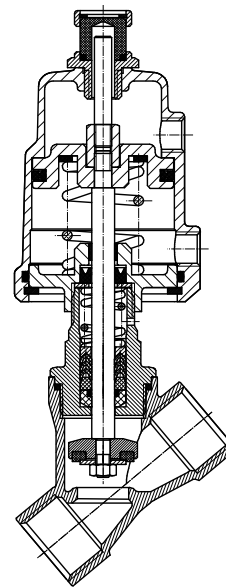

Normally Open Valve

PA Series - Normally Closed Valves Flow Direction **OVER** Seat



Model Numbers Shown are BSP threads

304 Stainless Steel Actuators
with 304 Stainless Steel Bodies



Size	Port Size	Orifice mm	Actuator mm	KV m ³ /h	Operating Pressure Differential bar	Minimum Pilot Control Pressure Range bar	Model Number	Net Weight Kg
DN10	3/8"	13	40	4.7	0-16	4	PA10S1G3S040S	0.78
			50	4.7	0-16	3	PA10S1G3S050S	1.01
DN15	1/2"	13	40	4.7	0-16	4	PA15S1G4S040S	0.80
			50	4.7	0-16	3	PA15S1G4S050S	1.03
DN20	3/4"	18	50	9.0	0-16	3-4	PA20S1G5S050S	1.06
DN25	1"	24	50	16.0	0-16	3-5.5	PA25S1G6S050S	1.38
			63	16.0	0-16	3-3.5	PA25S1G6S063S	2.05
DN32	1-1/4"	31	63	24.0	0-16	3-5	PA32S1G7S063S	2.40
DN40	1-1/2"	35	63	32.0	0-16	3-6	PA40S1G8S063S	2.75
DN50	2"	45	63	50.0	0-10	3-6.5	PA50S1G9S063S	3.50
			80	50.0	0-16	3-6.6	PA50S1G9S080S	4.62
			100	50.0	0-16	3-5	PA50S1G9S100S	5.16
DN65	2-1/2"	65	100	70.0	0-10	3-6	PA65S1GTS100S	8.65

304 Stainless Steel Actuators
with 316L Stainless Steel Bodies

Size	Port Size	Orifice mm	Actuator mm	KV m ³ /h	Operating Pressure Differential bar	Minimum Pilot Control Pressure Range bar	Model Number	Net Weight Kg
DN10	3/8"	13	40	4.7	0-16	4	PA10S1G3R040S	0.78
			50	4.7	0-16	3	PA10S1G3R050S	1.01
DN15	1/2"	13	40	4.7	0-16	4	PA15S1G4R040S	0.80
			50	4.7	0-16	3	PA15S1G4R050S	1.03
DN20	3/4"	18	50	9.0	0-16	3-4	PA20S1G5R050S	1.06
DN25	1"	24	50	16.0	0-16	3-5.5	PA25S1G6R050S	1.38
			63	16.0	0-16	3-3.5	PA25S1G6R063S	2.05
DN32	1-1/4"	31	63	24.0	0-16	3-5	PA32S1G7R063S	2.40
DN40	1-1/2"	35	63	32.0	0-16	3-6	PA40S1G8R063S	2.75
DN50	2"	45	63	50.0	0-10	3-6.5	PA50S1G9R063S	3.50
			80	50.0	0-16	3-6.6	PA50S1G9R080S	4.62
			100	50.0	0-16	3-5	PA50S1G9R100S	5.16
DN65	2-1/2"	65	100	70.0	0-10	3-6	PA65S1GTR100S	8.65

Control Pressure & Operating Pressure Charts for the Normally Closed Valves with 304 Stainless Steel Actuators

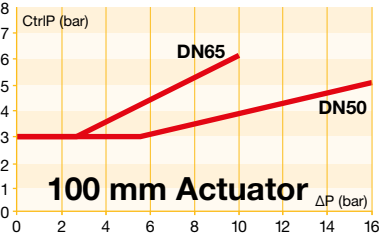
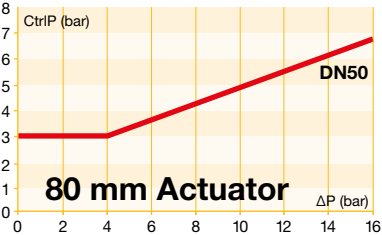
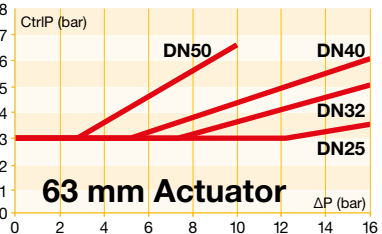
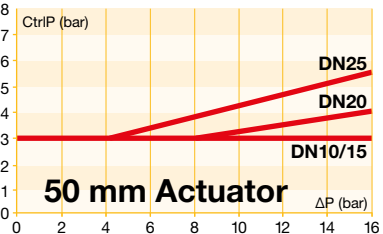
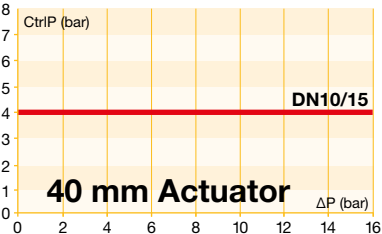

Flow Diagram

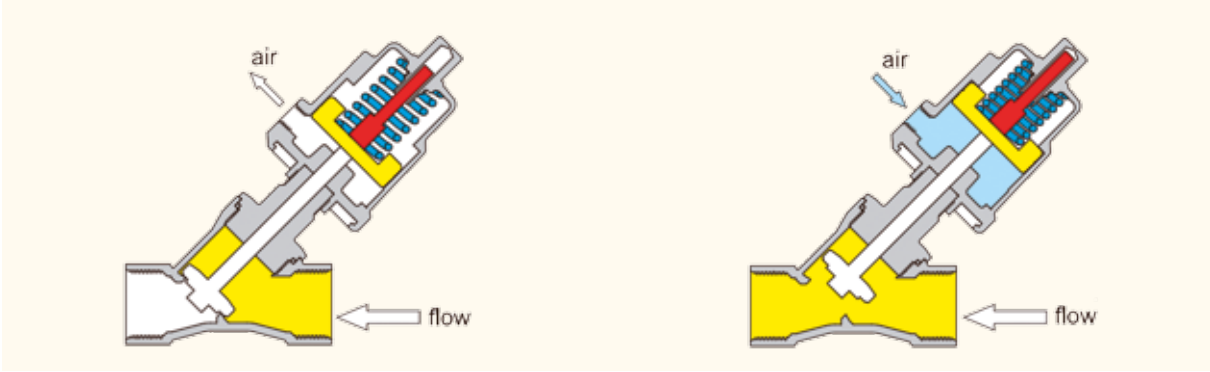

Valve Closed

Valve Open

PA Series - Normally Closed Valves Flow Direction **OVER** Seat

Model Numbers Shown are BSP threads

Aluminium Actuators
with 304 Stainless Steel Bodies



Size	Port Size	Orifice mm	Actuator mm	KV m ³ /h	Operating Pressure Differential bar	Minimum Pilot Control Pressure Range bar	Model Number	Net Weight Kg
DN10	3/8"	13	50	4.7	0-16	3	PA10S1G3S050A	0.75
DN15	1/2"	13	50	4.7	0-16	3	PA15S1G4S050A	0.80
DN20	3/4"	18	50	9.0	0-16	3-4	PA20S1G5S050A	0.90
DN25	1"	24	50	16.0	0-16	3-5.5	PA25S1G6S050A	1.27
			63	16.0	0-16	3-4	PA25S1G6S063A	1.65
DN32	1-1/4"	31	63	24.0	0-16	3-5.5	PA32S1G7S063A	1.89
DN40	1-1/2"	35	63	32.0	0-16	3-6.5	PA40S1G8S063A	2.15
			63	50.0	0-10	3-6.5	PA50S1G9S063A	2.98
			80	50.0	0-16	3-6.6	PA50S1G9S080A	3.56
DN50	2"	45	100	50.0	0-16	3-5	PA50S1G9S100A	4.75
			100	70.0	0-10	3-6	PA65S1GTS100A	5.50

Aluminium Actuators
with 316L Stainless Steel Bodies

Size	Port Size	Orifice mm	Actuator mm	KV m ³ /h	Operating Pressure Differential bar	Minimum Pilot Control Pressure Range bar	Model Number	Net Weight Kg
DN10	3/8"	13	50	4.7	0-16	3	PA10S1G3R050A	0.75
DN15	1/2"	13	50	4.7	0-16	3	PA15S1G4R050A	0.80
DN20	3/4"	18	50	9.0	0-16	3-4	PA20S1G5R050A	0.90
DN25	1"	24	50	16.0	0-16	3-5.5	PA25S1G6R050A	1.27
			63	16.0	0-16	3-4	PA25S1G6R063A	1.65
DN32	1-1/4"	31	63	24.0	0-16	3-5.5	PA32S1G7R063A	1.89
DN40	1-1/2"	35	63	32.0	0-16	3-6.5	PA40S1G8R063A	2.15
			63	50.0	0-10	3-6.5	PA50S1G9R063A	2.98
			80	50.0	0-16	3-6.6	PA50S1G9R080A	3.56
DN50	2"	45	100	50.0	0-16	3-5	PA50S1G9R100A	4.75
			100	70.0	0-10	3-6	PA65S1GTR100A	5.50

Control Pressure & Operating Pressure Charts for the Normally Closed Valves with Aluminum Actuators

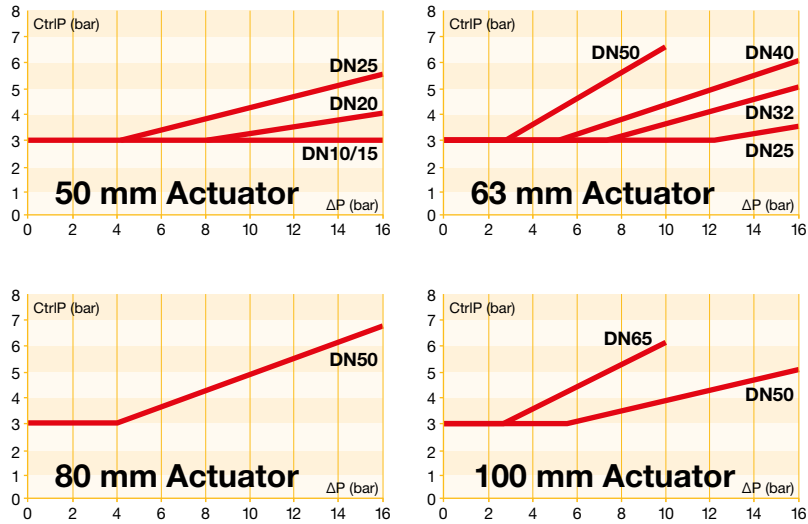

Flow Diagram

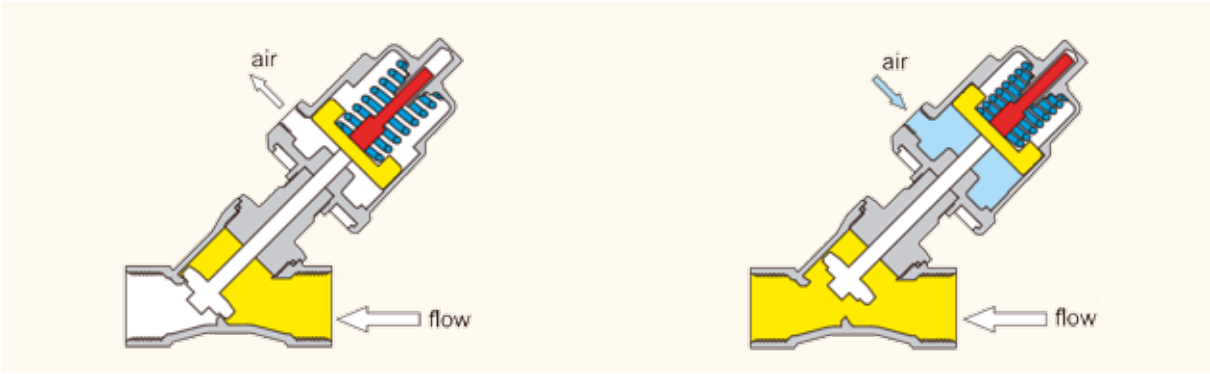

Valve Closed

Valve Open

PA Series - Normally Open Valves Flow Direction **OVER** Seat



Model Numbers Shown are BSP threads

304 Stainless Steel Actuators
with 304 Stainless Steel Bodies



Size	Port Size	Orifice mm	Actuator mm	KV m ³ /h	Operating Pressure Differential bar	Minimum Pilot Control Pressure bar	Model Number	Net Weight Kg
DN10	3/8"	13	50	4.7	0-16	3.5	PA10S2G3S050S	1.00
DN15	1/2"	13	50	4.7	0-16	3.5	PA15S2G4S050S	1.03
DN20	3/4"	18	50	9.0	0-16	3.5	PA20S2G5S050S	1.06
DN25	1"	24	63	16.0	0-16	4.5	PA25S2G6S063S	2.05
DN32	1-1/4"	31	63	24.0	0-14	4.5	PA32S2G7S063S	2.40
DN40	1-1/2"	35	63	32.0	0-11	4.5	PA40S2G8S063S	2.75
DN50	2"	45	63	50.0	0-6	5	PA50S2G9S063S	3.50
			80	50.0	0-12	5	PA50S2G9S080S	4.62

304 Stainless Steel Actuators
with 316L Stainless Steel Bodies

Size	Port Size	Orifice mm	Actuator mm	KV m ³ /h	Operating Pressure Differential bar	Minimum Pilot Control Pressure bar	Model Number	Net Weight Kg
DN10	3/8"	13	50	4.7	0-16	3.5	PA10S2G3R050S	1.00
DN15	1/2"	13	50	4.7	0-16	3.5	PA15S2G4R050S	1.03
DN20	3/4"	18	50	9.0	0-16	3.5	PA20S2G5R050S	1.06
DN25	1"	24	63	16.0	0-16	4.5	PA25S2G6R063S	2.05
DN32	1-1/4"	31	63	24.0	0-14	4.5	PA32S2G7R063S	2.40
DN40	1-1/2"	35	63	32.0	0-11	4.5	PA40S2G8R063S	2.75
DN50	2"	45	63	50.0	0-6	5	PA50S2G9R063S	3.50
			80	50.0	0-12	5	PA50S2G9R080S	4.62

Control Pressure & Operating Pressure

Charts do not apply for Normally Open Valves. A minimum pressure as noted above is all that is required, up to 10 bar Maximum.

Flow Diagram

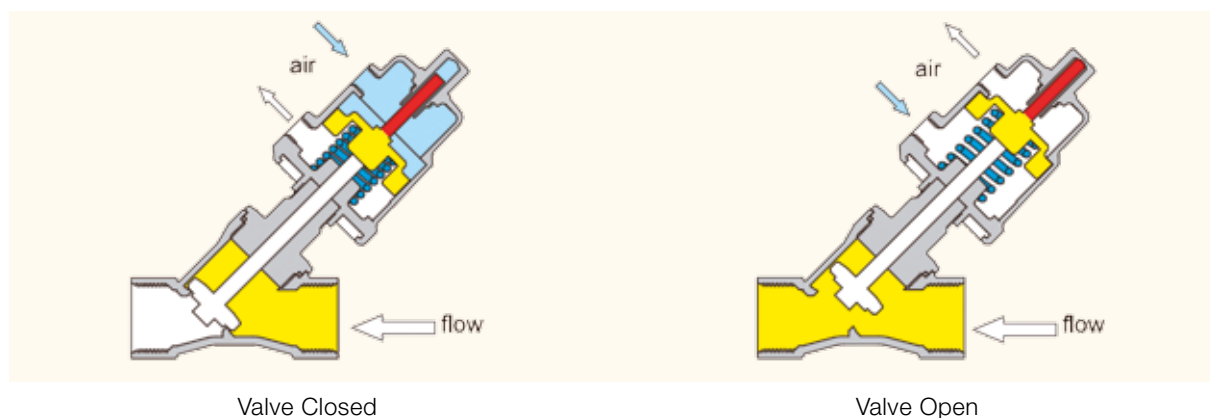

PA Series - Normally Closed Valves

Flow Direction UNDER Seat

Anti Water Hammer Construction

Model Numbers Shown are BSP threads

304 Stainless Steel Actuators
with 304 Stainless Steel Bodies



Size	Port Size	Orifice mm	Actuator mm	KV m ³ /h	Operating Pressure Differential bar	Minimum Pilot Control Pressure bar	Model Number	Net Weight Kg
DN10	3/8"	13	50	4.7	0-16	4.5	PA10SAG3S050S	1.01
DN15	1/2"	13	50	4.7	0-16	4.5	PA15SAG4S050S	1.03
DN20	3/4"	18	50	9.0	0-10	4.5	PA20SAG5S050S	1.06
DN25	1"	24	63	16.0	0-8	4.5	PA25SAG6S063S	2.05
DN32	1-1/4"	31	80	24.0	0-11	4	PA32SAG7S080S	3.82
DN40	1-1/2"	35	80	32.0	0-8	4	PA40SAG8S080S	4.07
			100	32.0	0-16	4	PA40SAG8S100S	4.61
DN50	2"	45	100	50.0	0-9	4	PA50SAG9S100S	5.16

304 Stainless Steel Actuators
with 316L Stainless Steel Bodies

Size	Port Size	Orifice mm	Actuator mm	KV m ³ /h	Operating Pressure Differential bar	Minimum Pilot Control Pressure bar	Model Number	Net Weight Kg
DN10	3/8"	13	50	4.7	0-16	4.5	PA10SAG3R050S	1.01
DN15	1/2"	13	50	4.7	0-16	4.5	PA15SAG4R050S	1.03
DN20	3/4"	18	50	9.0	0-10	4.5	PA20SAG5R050S	1.06
DN25	1"	24	63	16.0	0-8	4.5	PA25SAG6R063S	2.05
DN32	1-1/4"	31	80	24.0	0-11	4	PA32SAG7R080S	3.82
DN40	1-1/2"	35	80	32.0	0-8	4	PA40SAG8R080S	4.07
			100	32.0	0-16	4	PA40SAG8R100S	4.61
DN50	2"	45	100	50.0	0-9	4	PA50SAG9R100S	5.16

Flow Diagram

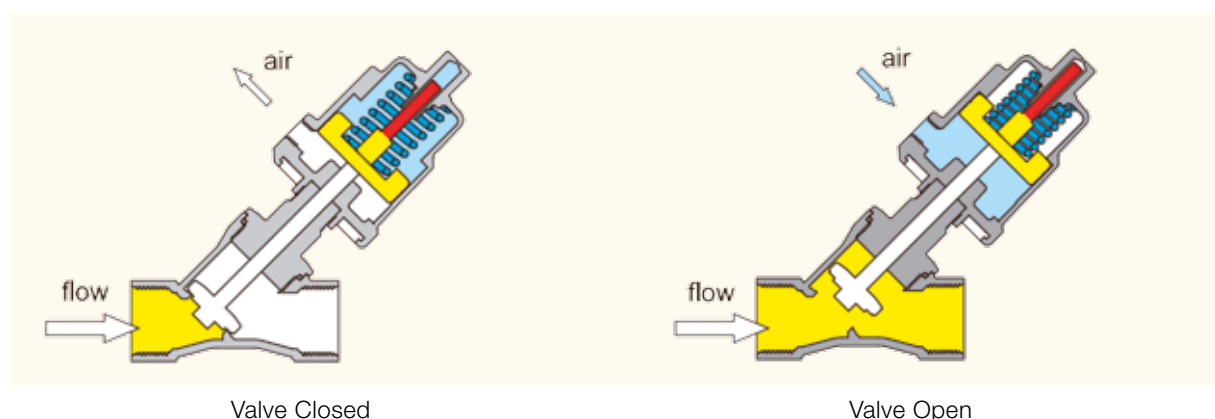

PA Series - Normally Closed Valves Flow Direction UNDER Seat

Anti Water Hammer Construction

Model Numbers Shown are BSP threads



Aluminum Actuators
with 304 Stainless Steel Bodies



Size	Port Size	Orifice mm	Actuator mm	KV m ³ /h	Operating Pressure Differential bar	Minimum Pilot Control Pressure bar	Model Number	Net Weight Kg
DN10	3/8"	13	50	4.7	0-16	4.5	PA10SAG3S050A	0.75
DN15	1/2"	13	50	4.7	0-16	4.5	PA15SAG4S050A	0.80
DN20	3/4"	18	50	9.0	0-10	4.5	PA20SAG5S050A	0.90
DN25	1"	24	63	16.0	0-8	4.5	PA25SAG6S063A	1.65
DN32	1-1/4"	31	80	24.0	0-11	4	PA32SAG7S080A	2.80
			80	32.0	0-8	4	PA40SAG8S080A	3.10
DN40	1-1/2"	35	100	32.0	0-16	4	PA40SAG8S100A	4.15
			100	50.0	0-9	4	PA50SAG9S100A	4.75

Aluminum Actuators with 316L Stainless Steel Bodies

Size	Port Size	Orifice mm	Actuator mm	KV m ³ /h	Operating Pressure Differential bar	Minimum Pilot Control Pressure bar	Model Number	Net Weight Kg
DN10	3/8"	13	50	4.7	0-16	4.5	PA10SAG3R050A	0.75
DN15	1/2"	13	50	4.7	0-16	4.5	PA15SAG4R050A	0.80
DN20	3/4"	18	50	9.0	0-10	4.5	PA20SAG5R050A	0.90
DN25	1"	24	63	16.0	0-8	4.5	PA25SAG6R063A	1.65
DN32	1-1/4"	31	80	24.0	0-11	4	PA32SAG7R080A	2.80
DN40	1-1/2"	35	80	32.0	0-8	4	PA40SAG8R080A	3.10
			100	32.0	0-16	4	PA40SAG8R100A	4.15
DN50	2"	45	100	50.0	0-9	4	PA50SAG9R100A	4.75

Control Pressure & Operating Pressure

Charts do not apply for Valves with flow direction Under Seat. A minimum pressure as noted above is all that is required, up to a maximum of 10 bar.

Flow Diagram

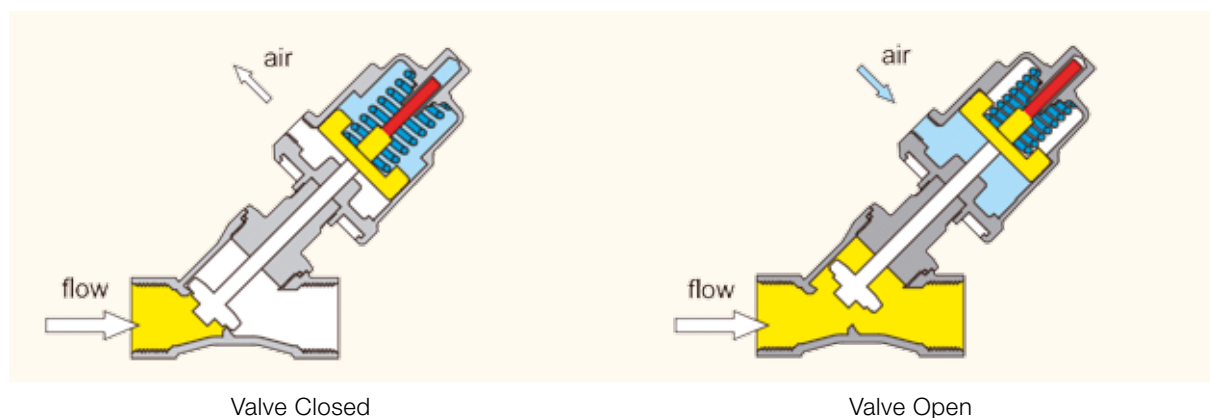

PA Series - Compact Design Normally Closed Valves-Flow direction OVER Seat



Model Numbers Shown are BSP threads

Media Temperature - 10°C to + 100°C



304 Stainless Steel Actuators with 304 Stainless Steel Bodies

Size	Port Size	Orifice mm	Actuator mm	KV m ³ /h	Operating Pressure Differential bar	Minimum Pilot Control Pressure Range bar	Model Number	Net Weight Kg
DN10	3/8"	13	32	4.7	0-16	4.5-6	PA10C3G3S032S	0.58
DN15	1/2"	13	32	4.7	0-16	4.5-6	PA15C3G4S032S	0.60
DN20	3/4"	15	32	5.4	0-14	4.5-6	PA20C3G5S032S	0.65

304 Stainless Steel Actuators with 316L Stainless Steel Bodies

Size	Port Size	Orifice mm	Actuator mm	KV m ³ /h	Operating Pressure Differential bar	Minimum Pilot Control Pressure Range bar	Model Number	Net Weight Kg
DN10	3/8"	13	32	4.7	0-16	4.5-6	PA10C3G3R032S	0.58
DN15	1/2"	13	32	4.7	0-16	4.5-6	PA15C3G4R032S	0.60
DN20	3/4"	15	32	5.4	0-14	4.5-6	PA20C3G5R032S	0.65

Media Temperature - 10°C to + 180°C

304 Stainless Steel Actuators with 304 Stainless Steel Bodies

Size	Port Size	Orifice mm	Actuator mm	KV m ³ /h	Operating Pressure Differential bar	Minimum Pilot Control Pressure Range bar	Model Number	Net Weight Kg
DN10	3/8"	13	32	4.7	0-16	4.5-6	PA10C1G3S032S	0.63
DN15	1/2"	13	32	4.7	0-16	4.5-6	PA15C1G4S032S	0.65
DN20	3/4"	15	32	5.4	0-14	4.5-6	PA20C1G5S032S	0.71

304 Stainless Steel Actuators with 316L Stainless Steel Bodies

Size	Port Size	Orifice mm	Actuator mm	KV m ³ /h	Operating Pressure Differential bar	Minimum Pilot Control Pressure Range bar	Model Number	Net Weight Kg
DN10	3/8"	13	32	4.7	0-16	4.5-6	PA10C1G3R032S	0.63
DN15	1/2"	13	32	4.7	0-16	4.5-6	PA15C1G4R032S	0.65
DN20	3/4"	15	32	5.4	0-14	4.5-6	PA20C1G5R032S	0.71

Control Pressure & Operating Pressure

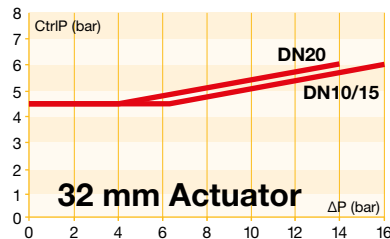

Flow Diagram

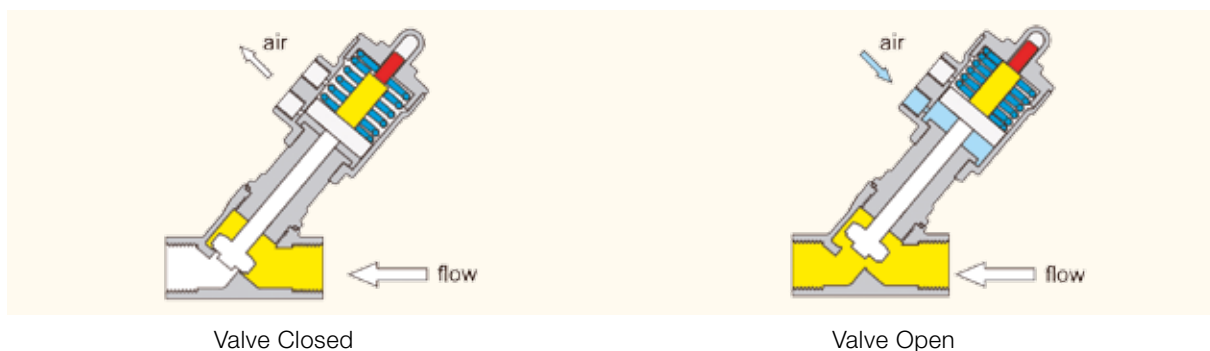

PA Series - Drawings and Dimensions

Stainless Steel Actuators Sizes 40, 50, 63, 80, 100 mm

Type	Actuator	D	R	P	K1	A1	G	L	T	SW
DN10	40	50.5	27	G1/8	116	121	G3/8	60	10	22 hexagon
	50	62	34	G1/8	130	133	G3/8	60	10	22 hexagon
DN15	40	50.5	27	G1/8	118	124	G1/2	65	11.5	25 hexagon
	50	62	34	G1/8	131	135	G1/2	65	11.5	25 hexagon
DN 20	50	62	34	G1/8	134	141	G3/4	75	14	31 hexagon
DN25	50	62	34	G1/8	141	153	G1	90	15	39 hexagon
	63	77	41.5	G1/8	164	175	G1	90	15	39 hexagon
DN32	63	77	41.5	G1/8	170	188	G1-1/4	110	18	50 octagon
	80	98	52	G1/4	184	205	G1-1/4	110	18	50 octagon
DN40	63	77	41.5	G1/8	181	201	G1-1/2	120	18	56 octagon
	80	98	52	G1/4	195	217	G1-1/2	120	18	56 octagon
	100	121	63	G1/4	213	235	G1-1/2	120	18	56 octagon
DN50	63	77	41.5	G1/8	189	216	G2	150	22	68 octagon
	80	98	52	G1/4	203	233	G2	150	22	68 octagon
DN65	100	121	63	G1/4	221	250	G2	150	22	68 octagon
	100	121	63	G1/4	248	285	G2-1/2	180	25	85 octagon

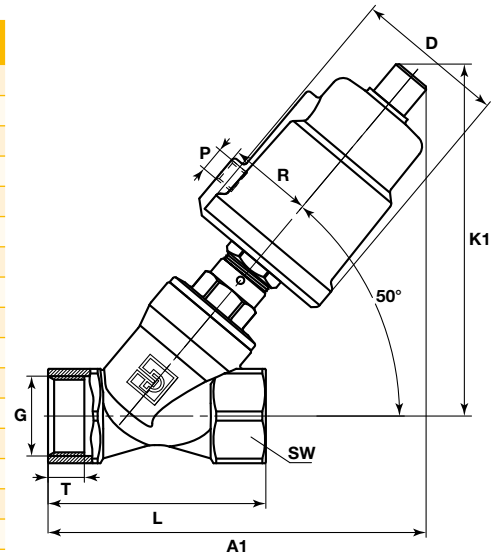

Aluminum Actuators Sizes 50, 63, 80, 100 mm

Type	Actuator	D	R	P	K1	A1	G	L	T	SW
DN10	50	61	38	G1/8	132	141	G3/8	60	10	22 hexagon
DN15	50	61	38	G1/8	133	144	G1/2	65	11.5	25 hexagon
DN20	50	61	38	G1/8	136	150	G3/4	75	14	31 hexagon
DN25	50	61	38	G1/8	144	162	G1	90	15	39 hexagon
	63	75	45	G1/8	167	183	G1	90	15	39 hexagon
DN32	63	75	45	G1/8	173	196	G1-1/4	110	18	50 octagon
	80	94	54	G1/4	192	214	G1-1/4	110	18	50 octagon
DN40	63	75	45	G1/8	184	209	G1-1/2	120	18	56 octagon
	80	94	54	G1/4	203	226	G1-1/2	120	18	56 octagon
	100	115	64	G1/4	223	245	G1-1/2	120	18	56 octagon
DN50	63	75	45	G1/8	192	224	G2	150	22	68 octagon
	80	94	54	G1/4	211	242	G2	150	22	68 octagon
DN65	100	115	64	G1/4	231	260	G2	150	22	68 octagon
	100	115	64	G1/4	257	294	G2-1/2	180	25	85 octagon

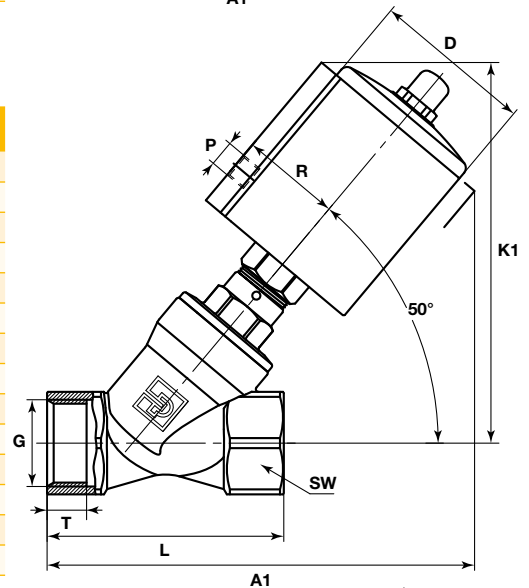

Stainless Steel Actuators Size 32 mm

Type	Actuator	Ø B	R	G1	K2		A2		G	L	T	SW
					Type C1/C2 (180°C)	Type C3/C4 (100°C)	Type C1/C2 (180°C)	Type C3/C4 (100°C)				
DN10	32	39.6	27	G1/8	107	94	117	106	G3/8	60	10	22 hexagon
DN15	32	39.6	27	G1/8	109	96	119	108	G1/2	65	11.5	25 hexagon
DN20	32	39.6	27	G1/8	112	100	126	115	G3/4	75	14	31 hexagon

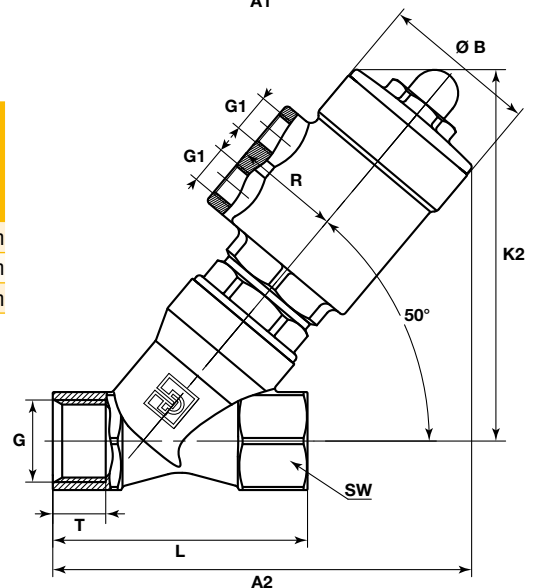

PA Series - Numbering System

Angle Seat Valve Numbering System

PA	10		S1		G3		S	063S	-
	Valve Size		Valve Type/Series		Body Thread Standard		Body Material	Actuator Description	Special
PA	10	DN10	S1	NC	G3	3/8	BSP	S 304 SS	Stainless Steel 304
PA	15	DN15	S2	NO	G4	1/2	BSP	R 316L SS	032S 32 mm actuator
PA	20	DN20	SA	NC, flow under seat	G5	3/4	BSP		040S 40 mm actuator
PA	25	DN25	C1	Compact, NC, flow over seat	G6	1	BSP		050S 50 mm actuator
PA	32	DN32	C2	Compact, NC, flow under seat	G7	1-1/4	BSP		063S 63 mm actuator
PA	40	DN40	C3	Compact NC, flow over seat (100°C)	G8	1-1/2	BSP		080S 80 mm actuator
PA	50	DN50	C4	Compact NC, flow under seat (100°C)	G9	2	BSP		100S 100 mm actuator
PA	65	DN65			GT	2-1/2	BSP		
									Aluminum
									040A 40 mm actuator
									050A 50 mm actuator
									063A 63 mm actuator
									080A 80 mm actuator
									100A 100 mm actuator



WARNING - USER RESPONSIBILITY

FAILURE OR IMPROPER SELECTION OR IMPROPER USE OF THE PRODUCTS DESCRIBED HEREIN OR RELATED ITEMS CAN CAUSE DEATH, PERSONAL INJURY AND PROPERTY DAMAGE.

- This document and other information from Parker-Hannifin Corporation, its subsidiaries and authorized distributors provide product or system options for further investigation by users having technical expertise.
- The user, through its own analysis and testing, is solely responsible for making the final selection of the system and components and assuring that all performance, endurance, maintenance, safety and warning requirements of the application are met. The user must analyze all aspects of the application, follow applicable industry standards, and follow the information concerning the product in the current product catalog and in any other materials provided from Parker or its subsidiaries or authorized distributors.
- To the extent that Parker or its subsidiaries or authorized distributors provide component or system options based upon data or specifications provided by the user, the user is responsible for determining that such data and specifications are suitable and sufficient for all applications and reasonably foreseeable uses of the components or systems.

Solenoid Valves for Controlling the PA Angle Seat Valves

3 Way Direct Acting Pilot Control Valves

Available as Separate Components

Features

- Compact designs
- Brass or Stainless steel body valves
- NC (normally closed) and NO (normally open) versions
- Broad offering of coils to meet World Wide requirements
- Available in BSP and NPT connections in 1/8" and 1/4" sizes

Representative Pictures



Banjo Valve for Direct Mounting to the Valve



Banjo Valve



Banjo Valve Mounted to the valve

Solenoid Valves for Controlling the PA Angle Seat Valves

3 Way Direct Acting Pilot Control Valves

Banjo Valve - Available as Separate Components

Banjo Valves G1/4" & G1/8" Series with Aluminium Body

Solenoid Operated Versions - B14-B04 Versions with 22 mm Coil

Port Size	Orifice	Q _N	Admissible differential pressure (bar) max.			Max. admissible fluid temperature (°C) Min. = -10°C	Seat disc	Reference number			Consumption Power (Watt)		Weight (g)	Dim. Ref.
			min	DC=	AC~			Air & Neutral gases	Valve	Housing	Coil	DC		
Banjo	G	mm	l/min											

3/2 Solenoid operated - Spring return (monostable)

1/8	1/8	1.2	50	0	10	10	50	NBR	131B14	-	496131	3	3	140	26
1/8	1/8	1.2	50	0	10	10	50	NBR	131B14	-	496482	3	3	150	26
1/8	1/8	1.2	50	0	10	10	50	NBR	131B14	-	496637	3	3	150	26
1/8	1/8	1.2	50	0	10	-	50	NBR	131B14	-	482605	5	-	170	26

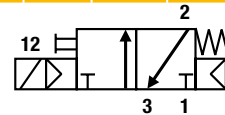

3/2 Solenoid operated - Spring return (monostable)

1/4	1/8	1.2	50	0	10	10	50	NBR	131B04	-	496131	3	3	160	27
1/4	1/8	1.2	50	0	10	10	50	NBR	131B04	-	496482	3	3	175	27
1/4	1/8	1.2	50	0	10	10	50	NBR	131B04	-	496637	3	3	175	27
1/4	1/8	1.2	50	0	10	-	50	NBR	131B04	-	482605	5	-	190	27

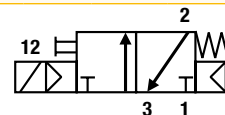

Dimensions Reference 26

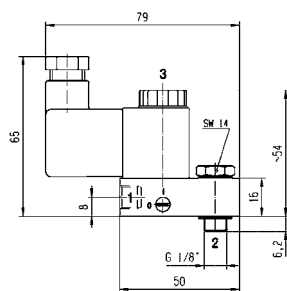

Dimensions Reference 27

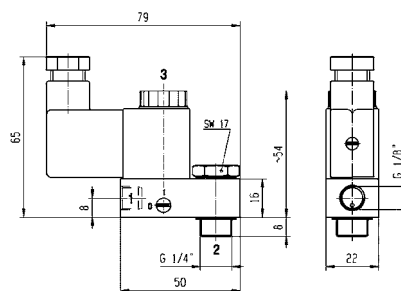

Coils 22 mm for Banjo Valves Series

These coils with connection for 2 P+G DIN 43650 B plug are encapsulated in synthetic material, conform to the IEC/CENELEC safety standards and comply with European low voltage directive 2006/95/EC. Banjo Valve bodies conform to the terms of the directive 94/9/CE specific to non electrical equipment for use within potentially explosive environments - Please select appropriate Coil for Safe Area or ATEX zones 1/21 or 2/22 in the following table.

- Power: 3 W or 5 W
- Insulation Class: F (155°C)
- Degree of Protection: IP65 (with plug)
- Duty Cycle: 100% ED

Available Voltages	Safe area without DIN plug Code	Safe area with DIN plug Code	For Zone 2/22 II 3 G-Ex nc AC IIC T5 II 3 D-Ex to AC IIC - T 95°C code with DIN plug	For Zone 1/21 II 2 G-Ex mb II T4 II 2 D-Ex tb IIC - T 130°C code includes DIN plug and 1.5 m cable
12 VDC	496131 C1	496482 C1	496637 C1	482605 C1
24 VDC	496131 C2	496482 C2	496637 C2	482605 C2
48 VDC	496131 C4	496482 C4	496637 C4	-
110 VDC	496131 C5	496482 C5	496637 C5	-
24/50-60 VAC	496131 P0	496482 P0	496637 P0	-
48/50-60 VAC	496131 S4	496482 S4	496637 S4	-
110/50-60 VAC	496131 P2	496482 P2	496637 P2	-
115/60 VAC	496131 K8	496482 K8	496637 K8	-
230/50-60 VAC	496131 P9	496482 P9	496637 P9	-

How to Order

Valve Reference Number - Coil Reference - Voltage code = Order code

Example: 131B14 - 496131 C2 - Valves and coils may be ordered also separately.



Parker's Motion & Control Technologies

At Parker, we're guided by a relentless drive to help our customers become more productive and achieve higher levels of profitability by engineering the best systems for their requirements. It means looking at customer applications from many angles to find new ways to create value. Whatever the motion and control technology need, Parker has the experience, breadth of product and global reach to consistently deliver. No company knows more about motion and control technology than Parker. For further info call 00800 27 27 5374



Aerospace Key Markets

Aftermarket services
Commercial transports
Engines
General & business aviation
Helicopters
Launch vehicles
Military aircraft
Missiles
Power generation
Regional transports
Unmanned aerial vehicles

Key Products

Control systems & actuation products
Engine systems & components
Fluid conveyance systems & components
Fluid metering, delivery & atomization devices
Fuel systems & components
Fuel tank inerting systems
Hydraulic systems & components
Thermal management
Wheels & brakes



Climate Control Key Markets

Agriculture
Air conditioning
Construction Machinery
Food & beverage
Industrial machinery
Life sciences
Oil & gas
Precision cooling
Process
Refrigeration
Transportation

Key Products

Accumulators
Advanced actuators
CO₂ controls
Electronic controllers
Filter driers
Hand shut-off valves
Heat exchangers
Hose & fittings
Pressure regulating valves
Refrigerant distributors
Safety relief valves
Smart pumps
Solenoid valves
Thermostatic expansion valves



Electromechanical Key Markets

Aerospace
Factory automation
Life science & medical
Machine tools
Packaging machinery
Paper machinery
Plastics machinery & converting
Primary metals
Semiconductor & electronics
Textile
Wire & cable

Key Products

AC/DC drives & systems
Electric actuators, gantry robots & slides
Electrohydraulic actuation systems
Electromechanical actuation systems
Human machine interface
Linear motors
Stepper motors, servo motors, drives & controls
Structural extrusions



Filtration Key Markets

Aerospace
Food & beverage
Industrial plant & equipment
Life sciences
Marine
Mobile equipment
Oil & gas
Power generation & renewable energy
Process
Transportation
Water Purification

Key Products

Analytical gas generators
Compressed air filters & dryers
Engine air, coolant, fuel & oil filtration systems
Fluid condition monitoring systems
Hydraulic & lubrication filters
Hydrogen, nitrogen & zero air generators
Instrumentation filters
Membrane & fiber filters
Microfiltration
Sterile air filtration
Water desalination & purification filters & system



Fluid & Gas Handling

Key Markets

Aerial lift
Agriculture
Bulk chemical handling
Construction machinery
Food & beverage
Fuel & gas delivery
Industrial machinery
Life sciences
Marine
Mining
Mobile
Oil & gas
Renewable energy
Transportation

Key Products

Check valves
Connectors for low pressure fluid conveyance
Deep sea umbilicals
Diagnostic equipment
Hose couplings
Industrial hose
Mooring systems & power cables
PTFE hose & tubing
Quick couplings
Rubber & thermoplastic hose
Tube fittings & adapters
Tubing & plastic fittings



Hydraulics

Key Markets

Aerial lift
Agriculture
Alternative energy
Construction machinery
Forestry
Industrial machinery
Machine tools
Marine
Material handling
Mining
Oil & gas
Power generation
Refuse vehicles
Renewable energy
Truck hydraulics
Turf equipment

Key Products

Accumulators
Cartridge valves
Electrohydraulic actuators
Human machine interfaces
Hybrid drives
Hydraulic cylinders
Hydraulic motors & pumps
Hydraulic systems
Hydraulic valves & controls
Hydrostatic steering
Integrated hydraulic circuits
Power take-offs
Power units
Rotary actuators
Sensors



Pneumatics

Key Markets

Aerospace
Conveyor & material handling
Factory automation
Life science & medical
Machine tools
Packaging machinery
Transportation & automotive

Key Products

Air preparation
Brass fittings & valves
Manifolds
Pneumatic accessories
Pneumatic actuators & grippers
Pneumatic valves & controls
Quick disconnects
Rotary actuators
Rubber & thermoplastic hose & couplings
Structural extrusions
Thermoplastic tubing & fittings
Vacuum generators, cups & sensors



Process Control

Key Markets

Alternative fuels
Biopharmaceuticals
Chemical & refining
Food & beverage
Marine & shipbuilding
Medical & dental
Microelectronics
Nuclear Power
Offshore oil exploration
Oil & gas
Pharmaceuticals
Power generation
Pulp & paper
Steel
Water/wastewater

Key Products

Analytical Instruments
Analytical sample conditioning products & systems
Chemical injection fittings & valves
Fluoropolymer chemical delivery fittings, valves & pumps
High purity gas delivery fittings, valves, regulators & digital flow controllers
Industrial mass flow meters/ controllers
Permanent no-weld tube fittings
Precision industrial regulators & flow controllers
Process control double block & bleeds
Process control fittings, valves, regulators & manifold valves



Sealing & Shielding

Key Markets

Aerospace
Chemical processing
Consumer
Fluid power
General industrial
Information technology
Life sciences
Microelectronics
Military
Oil & gas
Power generation
Renewable energy
Telecommunications
Transportation

Key Products

Dynamic seals
Elastomeric o-rings
Electro-medical instrument design & assembly
EMI shielding
Extruded & precision-cut, fabricated elastomeric seals
High temperature metal seals
Homogeneous & inserted elastomeric shapes
Medical device fabrication & assembly
Metal & plastic retained composite seals
Shielded optical windows
Silicone tubing & extrusions
Thermal management
Vibration dampening

ENGINEERING YOUR SUCCESS.

Parker Worldwide

Europe, Middle East, Africa

AE – United Arab Emirates,
Dubai

Tel: +971 4 8127100
parker.me@parker.com

AT – Austria, Wiener Neustadt

Tel: +43 (0)2622 23501-0
parker.austria@parker.com

AT – Eastern Europe, Wiener
Neustadt

Tel: +43 (0)2622 23501 900
parker.easteurope@parker.com

AZ – Azerbaijan, Baku

Tel: +994 50 2233 458
parker.azerbaijan@parker.com

BE/LU – Belgium, Nivelles

Tel: +32 (0)67 280 900
parker.belgium@parker.com

BG – Bulgaria, Sofia

Tel: +359 2 980 1344
parker.bulgaria@parker.com

BY – Belarus, Minsk

Tel: +48 (0)22 573 24 00
parker.poland@parker.com

CH – Switzerland, Etoy

Tel: +41 (0)21 821 87 00
parker.switzerland@parker.com

CZ – Czech Republic, Klecany

Tel: +420 284 083 111
parker.czechrepublic@parker.com

DE – Germany, Kaarst

Tel: +49 (0)2131 4016 0
parker.germany@parker.com

DK – Denmark, Ballerup

Tel: +45 43 56 04 00
parker.denmark@parker.com

ES – Spain, Madrid

Tel: +34 902 330 001
parker.spain@parker.com

FI – Finland, Vantaa

Tel: +358 (0)20 753 2500
parker.finland@parker.com

FR – France, Contamine s/Arve

Tel: +33 (0)4 50 25 80 25
parker.france@parker.com

GR – Greece, Athens

Tel: +30 210 933 6450
parker.greece@parker.com

HU – Hungary, Budaörs

Tel: +36 23 885 470
parker.hungary@parker.com

IE – Ireland, Dublin

Tel: +353 (0)1 466 6370
parker.ireland@parker.com

IT – Italy, Corsico (MI)

Tel: +39 02 45 19 21
parker.italy@parker.com

KZ – Kazakhstan, Almaty

Tel: +7 7273 561 000
parker.easteurope@parker.com

NL – The Netherlands, Oldenzaal

Tel: +31 (0)541 585 000
parker.nl@parker.com

NO – Norway, Asker

Tel: +47 66 75 34 00
parker.norway@parker.com

PL – Poland, Warsaw

Tel: +48 (0)22 573 24 00
parker.poland@parker.com

PT – Portugal, Leca da Palmeira

Tel: +351 22 999 7360
parker.portugal@parker.com

RO – Romania, Bucharest

Tel: +40 21 252 1382
parker.romania@parker.com

RU – Russia, Moscow

Tel: +7 495 645-2156
parker.russia@parker.com

SE – Sweden, Spånga

Tel: +46 (0)8 59 79 50 00
parker.sweden@parker.com

SK – Slovakia, Banská Bystrica

Tel: +421 484 162 252
parker.slovakia@parker.com

SL – Slovenia, Novo Mesto

Tel: +386 7 337 6650
parker.slovenia@parker.com

TR – Turkey, Istanbul

Tel: +90 216 4997081
parker.turkey@parker.com

UA – Ukraine, Kiev

Tel: +48 (0)22 573 24 00
parker.poland@parker.com

UK – United Kingdom, Warwick

Tel: +44 (0)1926 317 878
parker.uk@parker.com

ZA – South Africa, Kempton Park

Tel: +27 (0)11 961 0700
parker.southafrica@parker.com

North America

CA – Canada, Milton, Ontario

Tel: +1 905 693 3000

US – USA, Cleveland

Tel: +1 216 896 3000

Asia Pacific

AU – Australia, Castle Hill

Tel: +61 (0)2-9634 7777

CN – China, Shanghai

Tel: +86 21 2899 5000

HK – Hong Kong

Tel: +852 2428 8008

IN – India, Mumbai

Tel: +91 22 6513 7081-85

JP – Japan, Tokyo

Tel: +81 (0)3 6408 3901

KR – South Korea, Seoul

Tel: +82 2 559 0400

MY – Malaysia, Shah Alam

Tel: +60 3 7849 0800

NZ – New Zealand, Mt Wellington

Tel: +64 9 574 1744

SG – Singapore

Tel: +65 6887 6300

TH – Thailand, Bangkok

Tel: +662 186 7000

TW – Taiwan, Taipei

Tel: +886 2 2298 8987

South America

AR – Argentina, Buenos Aires

Tel: +54 3327 44 4129

BR – Brazil, Sao Jose dos Campos

Tel: +55 800 727 5374

CL – Chile, Santiago

Tel: +56 2 623 1216

MX – Mexico, Toluca

Tel: +52 72 2275 4200

Ed. 2013-12-06

EMEA Product Information Centre

Free phone: 00 800 27 27 5374

(from AT, BE, CH, CZ, DE, DK, EE, ES, FI, FR, IE, IL, IS, IT, LU, MT, NL, NO, PL, PT, RU, SE, SK, UK, ZA)

US Product Information Centre

Toll-free number: 1-800-27 27 537

www.parker.com

Your local authorized Parker distributor

